



# HANSA-TMP

MANUFACTURING YOUR SUCCESS

HT 16 / F / 852 / 0621 / E

## Load Sensing Control Valves

# Kawasaki

## Hydraulic Products

# KLSV18

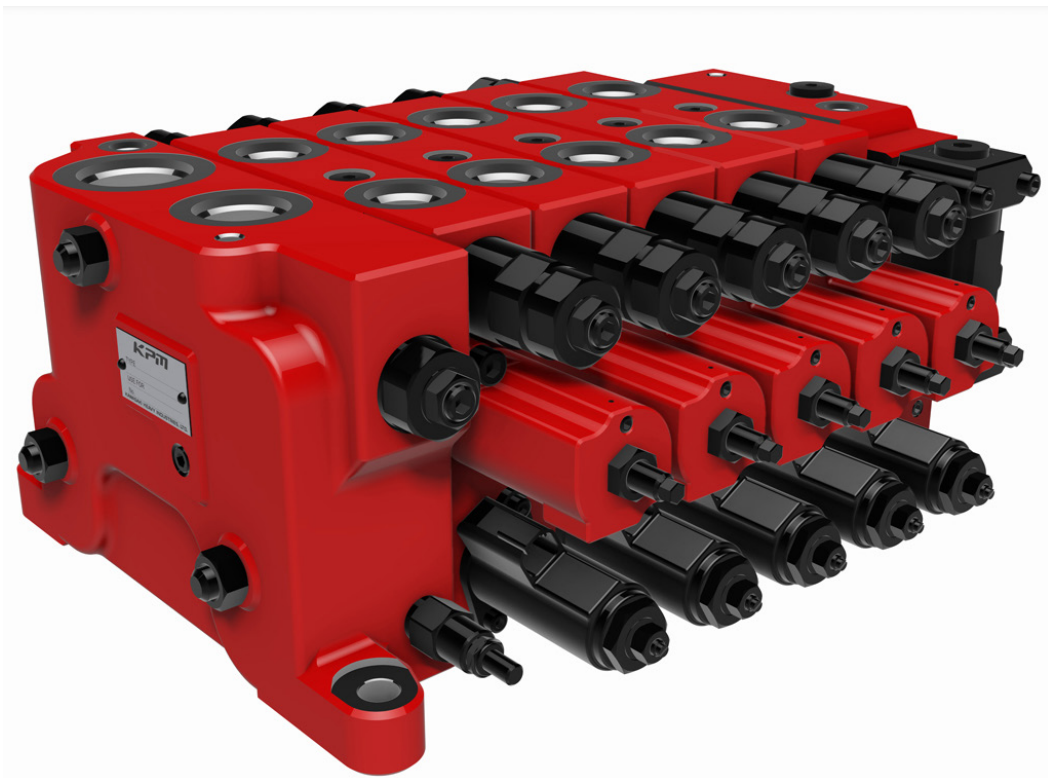



# CONTENTS

<b>I . Applications / Product Usage</b>	4
<b>II . Safety Precautions</b>	5
<b>III . Handling Precautions</b>	6
<b>IV . Conversion Factors and Definition</b>	7
<b>1. General Information of the Products</b>	8
1-1. Ordering Code	9
1-2. Configuration	9
1-3. Specifications	11
<b>2. Inlet Section</b>	
2-1. Function	12
2-2. Specifications	13
2-3. Technical Information	14
<b>3. Spool Section</b>	
3-1. Function	15
3-2. Specifications	16
3-3. Technical Information	17
3-4. Optional Function	18
<b>4. End Cover</b>	
4-1. Function	19
4-2. Specifications	19
<b>5. Adjustment Instruction</b>	20
<b>6. Dimensions</b>	
6-1. General Dimension (with all option)	21
6-2. Port size	22
<b>7. Ordering Sample</b>	23
Inquiry Form	24

# I . Applications / Product Usage

The following must be taken into consideration before use.

1. The operating condition of the products shown in this catalog varies depending upon each application. Therefore, the suitability of the products use must be made by the designer of the hydraulic system and/or the person in charge of determining the machine's specifications after analysis and testing.  
The product specification shall be determined based on the latest catalog and technical documents. The system must be designed taking into account the possibility of machine failure, and insuring that all safety, warning, and application requirements are met.
2. For the proper use of the products, descriptions given in the SAFETY PRECAUTIONS must be observed.
3. The technical information in this catalog represents typical characteristics and performance of the products as of the published date.
4. If the products are used in the following conditions or environments, please consult our Tech. Dept. prior to implementation.
  - (1) Unspecified conditions or environments
  - (2) Atomic power, aviation, medical treatment, and/or food production
  - (3) Use likely to affect human beings or assets significantly or requiring particular safety.
5. The information described in this catalog is subject to change without notice. For updated information, please consult our Tech Dept.

## II. Safety Precautions

Before using the product, you **MUST** read the catalog and **MUST** fully understand how to use the product. To use the product safely, you **MUST** carefully read all Warnings and Cautions in this catalog.

### 1. Cautions related to operation



- Use safety equipment to avoid the injury when you operate the product.



- Pay close attention while handling the product to avoid injury that may be caused by the heavy weight of the product or improper handling posture.



- Do not step on, hit, drop or give strong outside force to the product, as one of these actions may cause failure of operation, damage, or oil leakage.



- Wipe off any oil on the product or floor completely, as the oil creates slippery conditions that may result in dropping the product or personal injury.

### 2. Warnings and Cautions related to installation and removal of the product



- Installation, removal, plumbing, and wiring must be done by a qualified technician.



- Make sure that the hydraulic power unit is turned off and that the electric motor or engine has completely stopped before starting installation or removal. You must also check that the system pressure has dropped to zero.



- Turn off the power before wiring or performing other duties related to the electric power to avoid risk of electric shock.



- Clean the threads and mounting surface completely to prevent damage or oil leakage caused by insufficient tightening torque or broken seal.



- Use the specified bolts and maintain the specified tightening torque when you install the product. Usage of unauthorized bolts, lack of torque or excess torque may create problems such as failure of operation, damage, and oil leakage.

### 3. Warnings and Cautions for operation



- Always equip the product with anti-explosion protection in the circumstances of possible explosion or combustion.



- Shield rotating parts, such as the motor and pump shaft, to avoid injuries.



- Stop operation immediately if you find unusual noise, oil leakage or smoke, and fix properly. Continuing operation may cause damage, fire or injury.



- Make sure that plumbing and wiring are correctly connected and tightened before operation.



- Use the product according to the specifications provided in the catalog, drawings and specification sheets.



- The product may become hot during operation.



- Use the proper hydraulic oil and maintain the filtration at the recommended level to prevent premature wear and damage.

### 4. Cautions related to maintenance



- Never modify the product without approval from our Tech Dept.



- Disassembly of the product may void the warranty.



- Keep the product clean and dry when storing or transporting.



- The seals may need to be replaced if the product has been stored for an extended period of time.

## III. Handling Precautions

### 1. Operating fluid and Temperature range

#### 1) Operating fluid

Values shown in this catalog are based upon using mineral oil based anti-wear hydraulic fluid. If using special fluid (phosphate ester, water-glycol, fatty acid ester, etc), please consult our Tech. Dept. for instructions prior to use.

#### 2) Viscosity and Temperature range

Allowable viscosity and temperature range is shown in the table below. However, to minimize both oil and seal deterioration maximum operating temperature of 60 °C should be considered.

	Allowable range
Viscosity [mm <sup>2</sup> /s]	5~500
Temperature [°C]	-20~+90 (-4~+194)

### 2. Cleanliness

For satisfactory service life and performance, operating fluid should be continuously filtered to maintain the required cleanliness level of ISO4406 -/18/15 (NAS1638 Class9).

Clean fittings, hose and pipe thoroughly to prevent any debris from entering into the hydraulic system.

### 3. Installation

Flatness of mounting face on which the valve is installed shall be 0.1mm or less.

Mount the valve on the machine frame by using three bolts of size M12 or ½-13UNC.

The drain piping must be connected directly to the tank. The piping size shall be equal to or larger than the port size.

Do not apply any form of external force to the solenoid valves.

## IV. Conversion Factors and Definition

### ◆ Conversion Factors

Item	Formula	Note
Pressure	1 MPa = 145 psi	
Flow	1 L/min = 0.264 gpm	US gallon
Length	1 mm = 0.0394 in	
Mass	1 kg = 2.21 lbf	
Torque	1 Nm = 0.738 lb ft	

### ◆ Definition

---

P	=	Pump port of the Inlet section
---	---	--------------------------------

---

LS	=	Load sensing port of the Inlet section
----	---	--

---

T	=	Tank port of the Inlet section
---	---	--------------------------------

---

$\Delta P$	=	Differential pressure between P and LS port
------------	---	---

---

A, B	=	Work port A or B of the Spool section
------	---	---------------------------------------

---

Pa, Pb	=	Pilot pressure port (Hydraulic control)
--------	---	---

---

Pi	=	Pilot pressure port for external supply (Electro-Hydraulic control)
----	---	---

---

Dr	=	Drain port of the End cover
----	---	-----------------------------

---

# KLSV18

## Load Sensing Control Valve

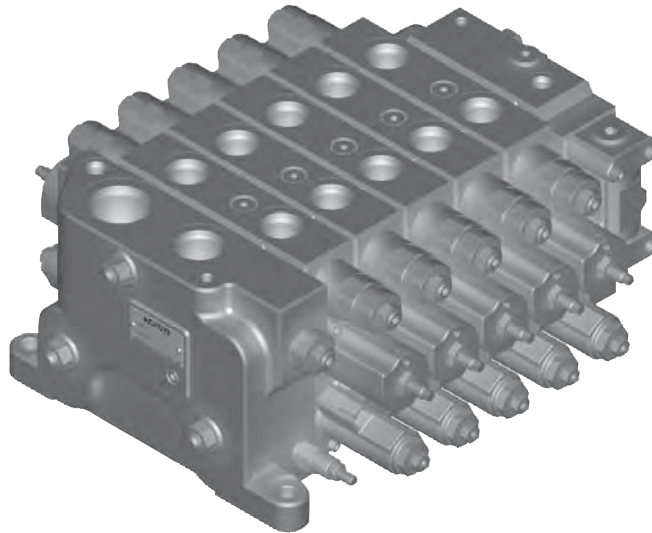

### ■ Specifications

Size: 18

Maximum Pressure

Inlet section: 40 MPa

Spool section: 40 MPa

Maximum Flow

Inlet section: 240 L/min

Spool section: 180 L/min\*

(\* Differential pressure  $\Delta P = 1.5\text{MPa}$ )

### ■ General Descriptions

KLSV series is valve which consists of several sections.

This control valve is designed to control actuators on construction and industrial vehicles.

Closed center load sensing system can be realized in combination with a variable displacement pump.

Superior control is achieved with various functions such as anti-saturation.

### ■ Features

#### 1. Superior control performance

Flow can be controlled independently of the load pressure even in multiple control.

Anti-saturation function enables a constant flow rate among each section.

#### 2. Energy saving

Low pressure loss is achieved with optimum design.

#### 3. High pressure

High pressure capability enables the hydraulic system more efficient and compact.



# 1 General Information of the Products

## 1-1 Ordering Code

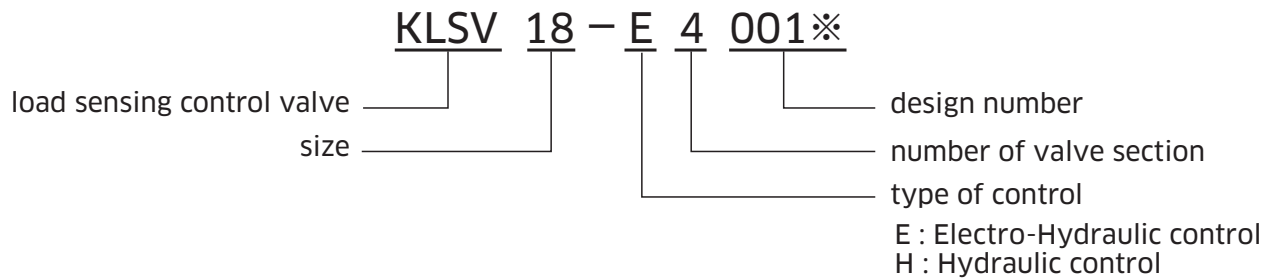

## 1-2 Configuration

The KLSV load sensing valve consists of three sections, one inlet section, a number of spool sections and one end cover.

### ◆ General drawing

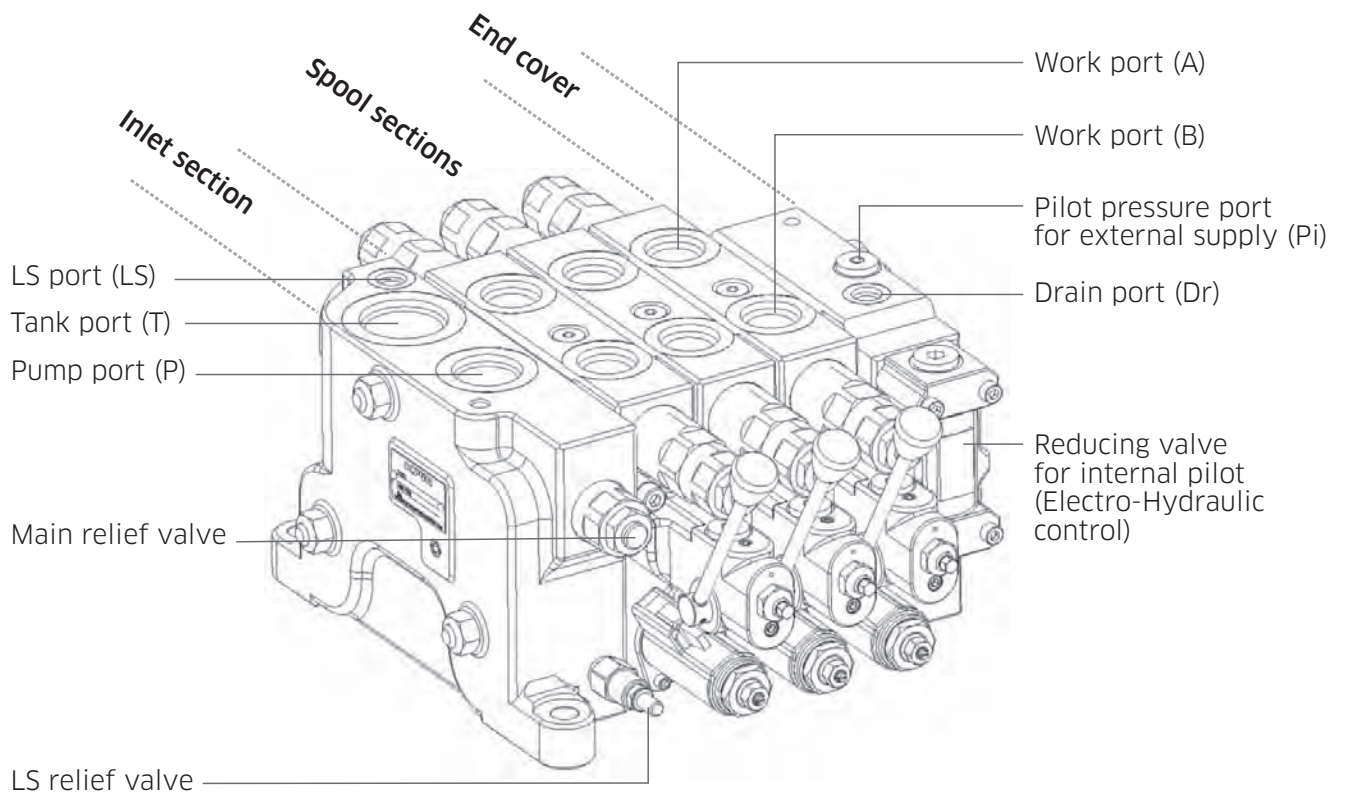

◆ Structure of the Spool section

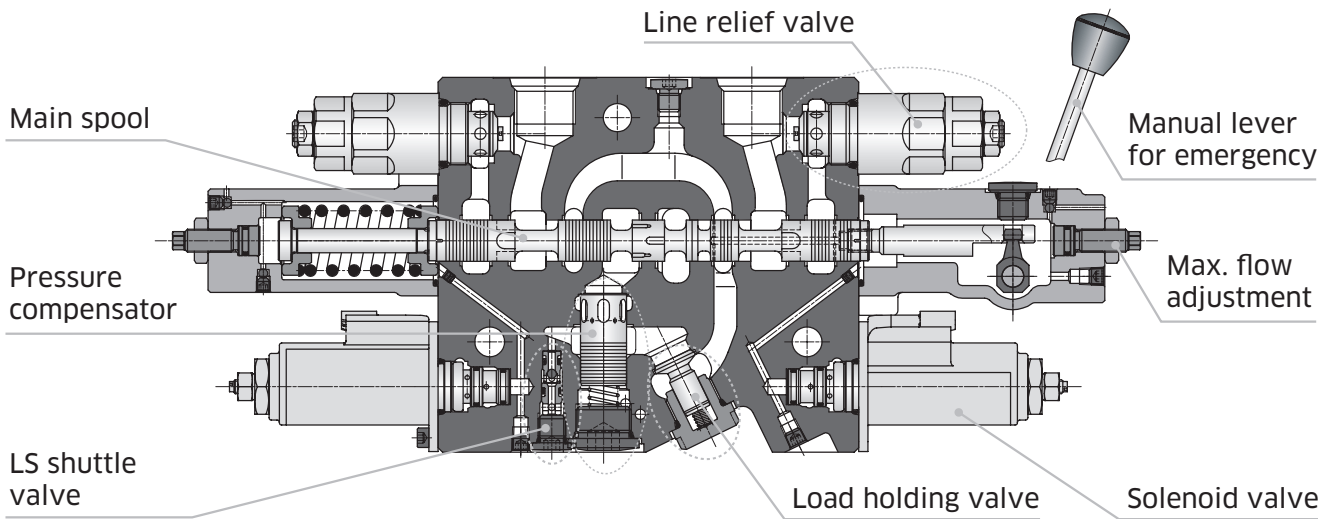

◆ Hydraulic circuit

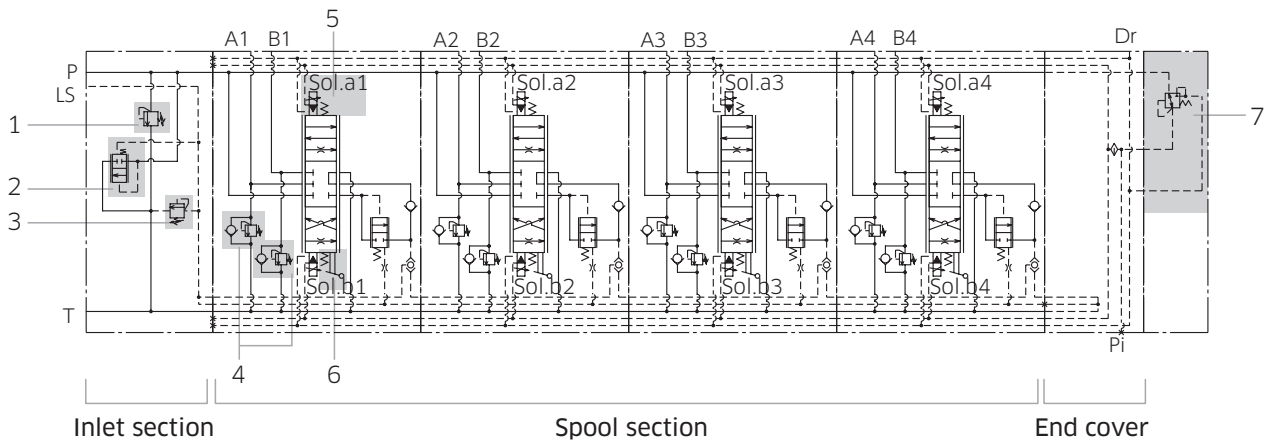

◆ Inlet section

- 1. Main relief valve
- 2. Unloading valve
- 3. LS relief valve

◆ Spool section

- 4. Line relief valve
- 5. Solenoid valve for Electro-Hydraulic control
- 6. Manual lever for emergency

◆ Other function

- 7. Reducing valve for internal pilot (Electro-Hydraulic control)

## 1. General Information of the Products

### 1-3 Specifications

#### ◆ General specifications

Model		KLSV18
Maximum pressure	MPa	40
Maximum flow L/min (gallon/min)	P port	240
	A, B port	180 *1
Leakage (A, B port → T port) at 7 MPa, 30 mm <sup>2</sup> /s cm <sup>3</sup> /min		25
Pilot pressure for Hydraulic control	MPa	0~3
External pilot pressure for Electro-Hydraulic control	MPa	3~5
Maximum number of Spool sections		9
Mass	kg	
	Inlet section	16 *2
	Spool section	12 *3
	End cover	12 *4

\*1 : At  $\Delta P = 1.5$  MPa

\*2 : In case the main relief valve, LS relief valve, and unloading valve are attached.

\*3 : In case two port relief valves and solenoid valves are attached.

\*4 : In case the reducing valve for internal pilot is attached.

#### ◆ Electrical specifications

Rated current	mA	700	1600
Coil resistance value (20°C)	$\Omega$	17.5	3.3
Recommended dither condition		85Hz 300mAp-p at 400mA	85Hz 600mAp-p at 900mA
Waterproofing property		IP65	
Connector type		Deutsch DT04-2P	

# 2 Inlet Section

## 2-1 Function

There are Pump port (P), LS port (LS), and Tank port (T) in the Inlet section.

The valves (Main relief valve, LS relief valve, Unloading valve) which are needed for the control system are attached.

Main relief valve is standard installation.

LS relief valve and unloading valve can be attached in combinations shown in the following table according to the control system design.

In case the pump delivers minimum standby flow at neutral condition, the unloading valve should be attached.

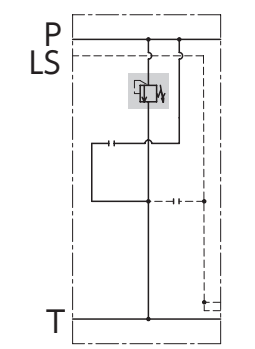
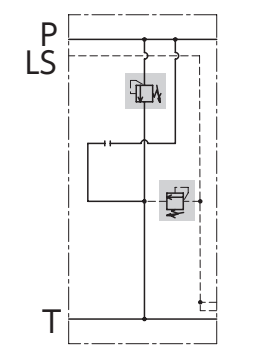
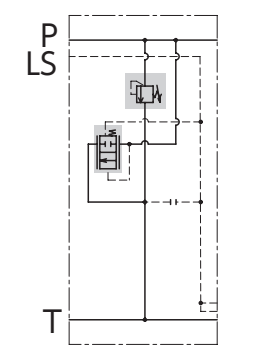
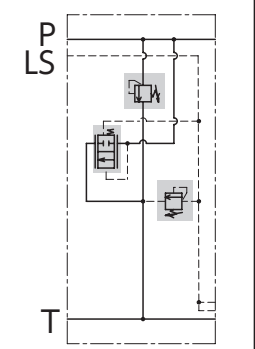
	Type A	Type B	Type C	Type D
Main relief valve *	●	●	●	●
LS relief valve		●		●
Unloading valve			●	●
Hydraulic circuit				

\* See page 14 for the technical information about main relief valves.

## 2. Inlet Section

### 2-2 Specifications

#### ◆ General specifications

Maximum pressure	MPa	P port	40
		LS port	40
		T port	1
Maximum flow	L/min	P port	240

#### ◆ Main relief valve

Set pressure range	MPa	18~40
Maximum flow	L/min	300

\* Main relief valve setting can be adjusted.  
Refer to page 20 for "Adjustment instruction".

#### ◆ LS relief valve

Set pressure range	MPa	7~40
Maximum flow	L/min	45

\* LS relief valve setting can be adjusted.  
Refer to page 20 for "Adjustment instruction".

#### ◆ Unloading valve

Cracking pressure	MPa	2.7~3.3
Maximum flow	L/min	50

## 2-3 Technical Information

Main relief valve is attached as standard.

Main relief valve can be adjusted to the required pressure. Please specify the requirement with the inquiry form in page 24.

Detail for adjustment is shown in page 20.

Override characteristic of the main relief valve is shown below.

### ◆ Override Characteristic (Main relief valve)

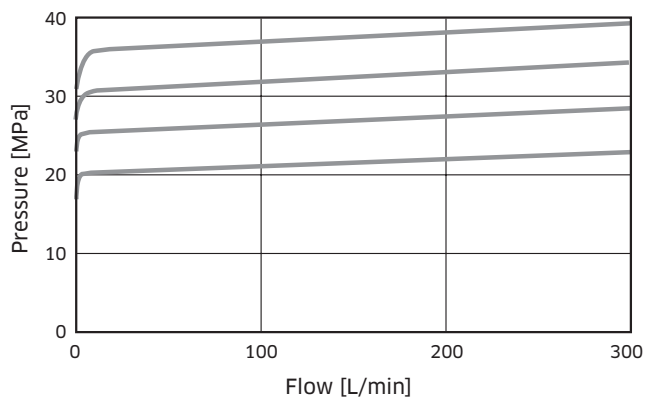

# 3 Spool Section

## 3-1 Function

Spool section mainly consists of a main spool and pressure compensator, a load holding valve, etc. Position of main spool is switched with Hydraulic pilot control or Electro-Hydraulic control, and oil is supplied to an actuator from a work port A or B. The line relief valve can be attached on each work port if needed. Type of control can be chosen from two types shown below. Typical combinations of functions are shown below (Type A~F). The line relief valve can be attached on each work port A and B as required. Manual lever for emergency is available when the Electro-Hydraulic control is used.

### ◆ Hydraulic control

Code	Type A	Type B
Standard *1	●	●
Line relief valve *2		●
Hydraulic circuit		

### ◆ Electro-Hydraulic control

Code	Type C	Type D	Type E	Type F
Standard *1	●	●	●	●
Line relief valve *2		●	●	
Manual lever for emergency *3			●	●
Hydraulic circuit				

\*1 : It mainly consists of a main spool, pressure compensator, LS shuttle valve and load holding valve.  
 \*2 : See to page 18 for the characteristic of the Line relief valve.  
 \*3 : See to page 18 for the Manual lever for emergency.

## 3-2 Specifications

### ◆ General specifications

Maximum pressure	MPa	A, B port	40
		Pa, Pb port	3
Maximum flow at $\Delta P = 1.5$ MPa	L/min	A, B port	180

### ◆ Line relief valve

Pressure setting code		100	200	350
Set pressure range	MPa	3~15	10~21	17~40
Maximum flow	L/min	300		

Refer to page 20 for "Adjustment Instruction".

### ◆ Spool type

Each spool used with a spool section can be chosen from three types shown below.

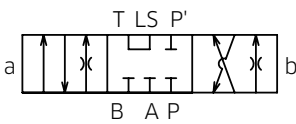
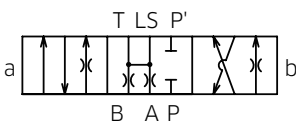
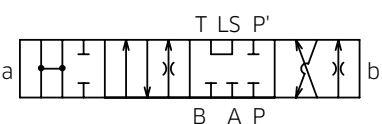
Type of the Spool	Symbol	Description
Three position spool (Standard)		All port closed at neutral position. Mainly for a cylinder as actuator.
Three position spool (Motor with restriction)		A, B port are drained to tank under some restriction at neutral position. Mainly for a motor as actuator.
Four position spool with float function		All port closed at neutral position. Float function can be included in "a" side or "b" side. At floating condition the work port A and B are connected to T port.

For other type please consult with our Tech. Dept.



### 3. Spool Section

## 3-3 Technical Information

### ◆ Flow control characteristics

Maximum flow of each spool section can be chosen from six types shown in the following table. Relationship between flow rate and pilot pressure or input current to the solenoid valves is as shown below. Please choose the optimal spool in consideration of necessary flow rate and the control sensitivity. Maximum flow of each port can be individually chosen from the table. Maximum flow can be adjusted by adjustment mechanism of each section. For detail of adjustment see page 20.

Table. Maximum flow of the spool

Spool code	Spool maximum flow (L/min)
A	180
B	150
C	120
D	90
E	60
F	30

[Note]  
Flow control characteristic is at  $\Delta P = 1.5$  MPa.

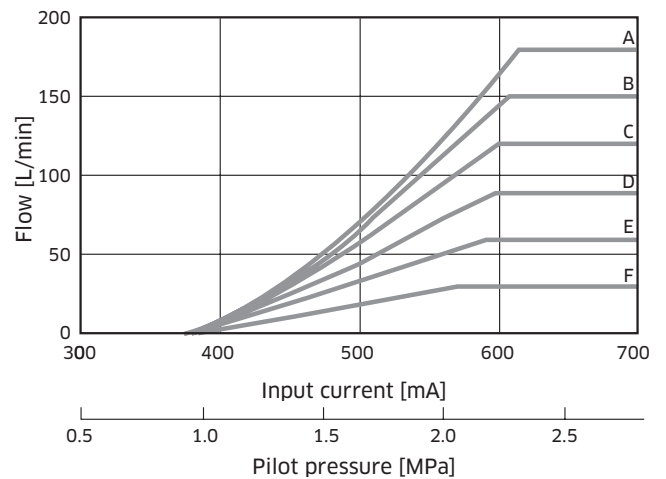

### ◆ Pressure drop [P to A, B]

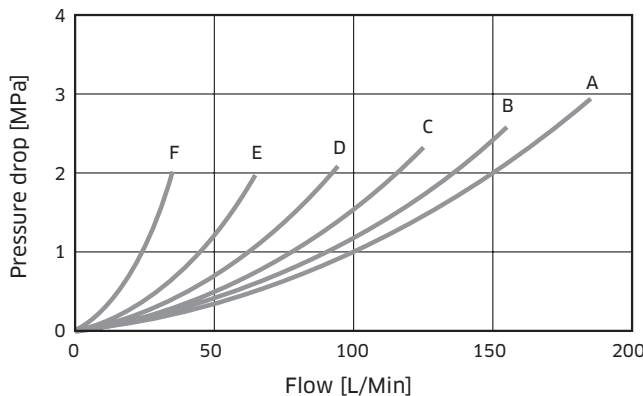

### ◆ Pressure drop [A, B to T]

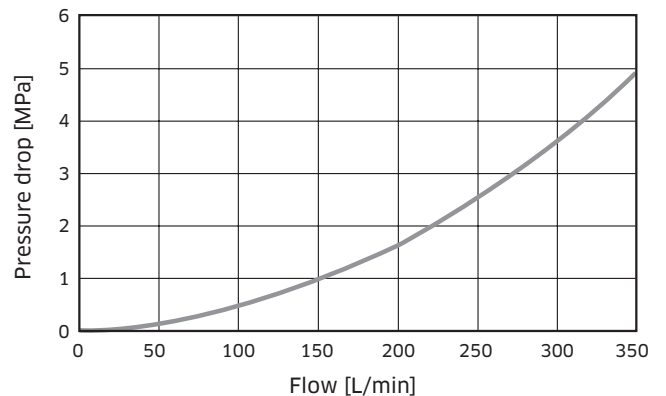

## 3-4 Optional Function

Line relief valve and manual lever for emergency can be attached as required.

### ◆ Characteristics of Line relief valve

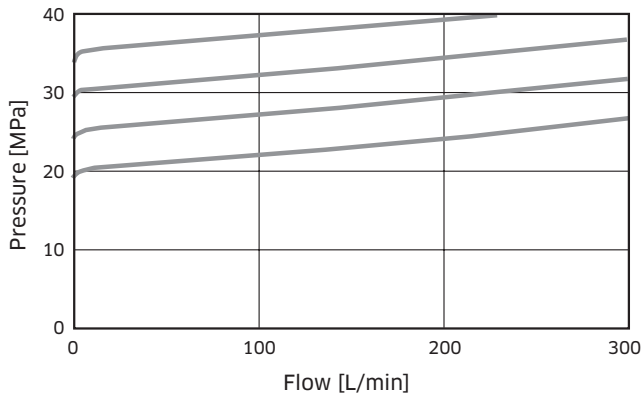

Line relief valve can be adjusted to the required pressure for each work port.

Please specify the requirement with the inquiry form in page 24.

Detail for adjustment is shown in page 20.

### ◆ Manual lever for emergency

Manual lever for emergency is only available in case of Electro-Hydraulic control.

Manual lever for emergency is attached in order to move a spool manually when electrical system is failed. It is not the purpose to operate manually at all time.

The movement range of the lever is shown in the figure right. Please secure full valve mounting space for there to be no interference with the machine structure and to be able to perform manual operation at the time of emergency satisfactorily.

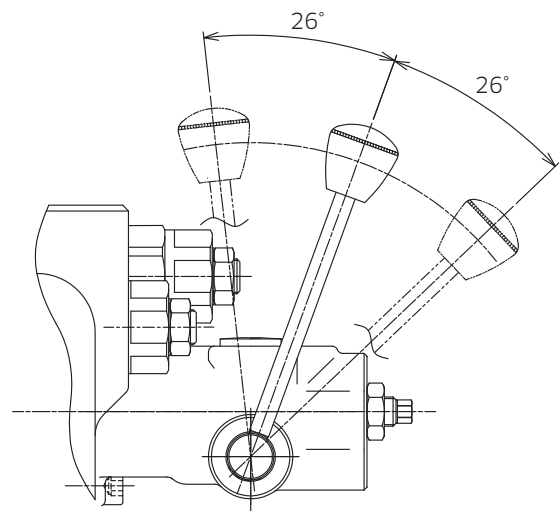

Allowable maximum operating force	245 N
Operating angle	±26°

# 4 End Cover

## 4-1 Function

End cover is a cover attached at the end face of final section.

In case of Electro-Hydraulic control (External pilot), primary proportional solenoid valve pressure is supplied to Pi port of End cover.

In case of Electro-Hydraulic control (Internal pilot), the reducing valve for reducing pump pressure to primary pressure for the solenoid valve is attached.

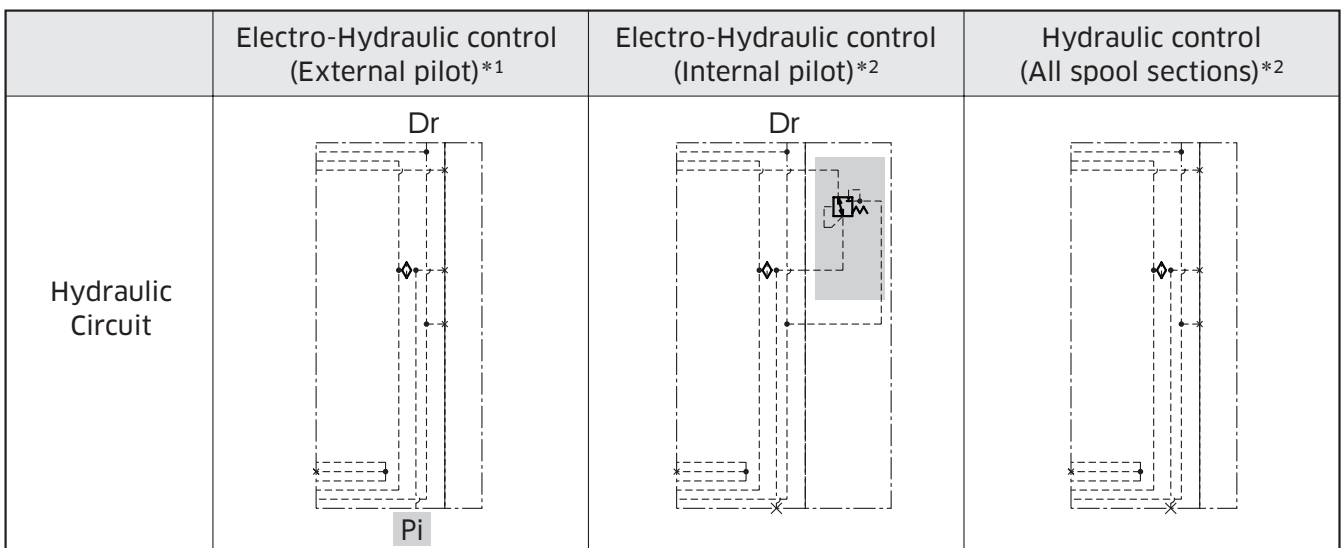

\* 1 : In case of Electro-Hydraulic control (External pilot), pilot pressure needs to be supplied to Pi port.

\* 2 : In case of Electro-Hydraulic control (Internal pilot) and Hydraulic control, Pi port is not used.

## 4-2 Specifications

### ◆ In case of Electro-Hydraulic control (External pilot)

Dr port pressure	MPa	0.15.....
External pilot pressure for Electro-Hydraulic control	MPa	3.0~5.0

### ◆ In case of Electro-Hydraulic control (Internal pilot)

Dr port pressure	MPa	0.1.....
------------------	-----	----------

\* Pi port is not used.

### ◆ In case of Hydraulic control (All spool sections)

Dr and Pi ports are not to be used.	—
-------------------------------------	---

# 5 Adjustment Instruction

For Inlet section and spool section the maximum flow and relief valve setting pressure can be adjusted to the required specification.

Tightening torque and adjustable pressure range are shown below.

## ◆ Inlet section

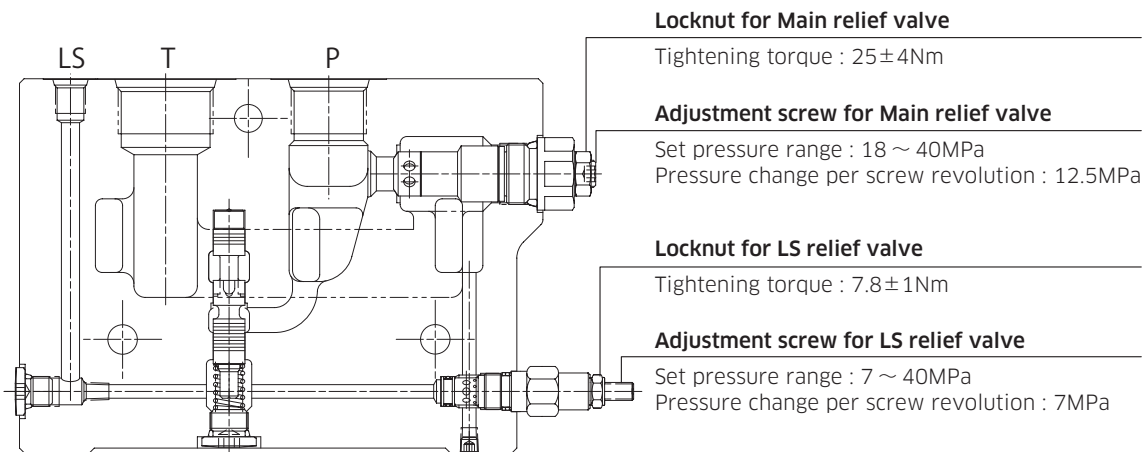

## ◆ Spool section

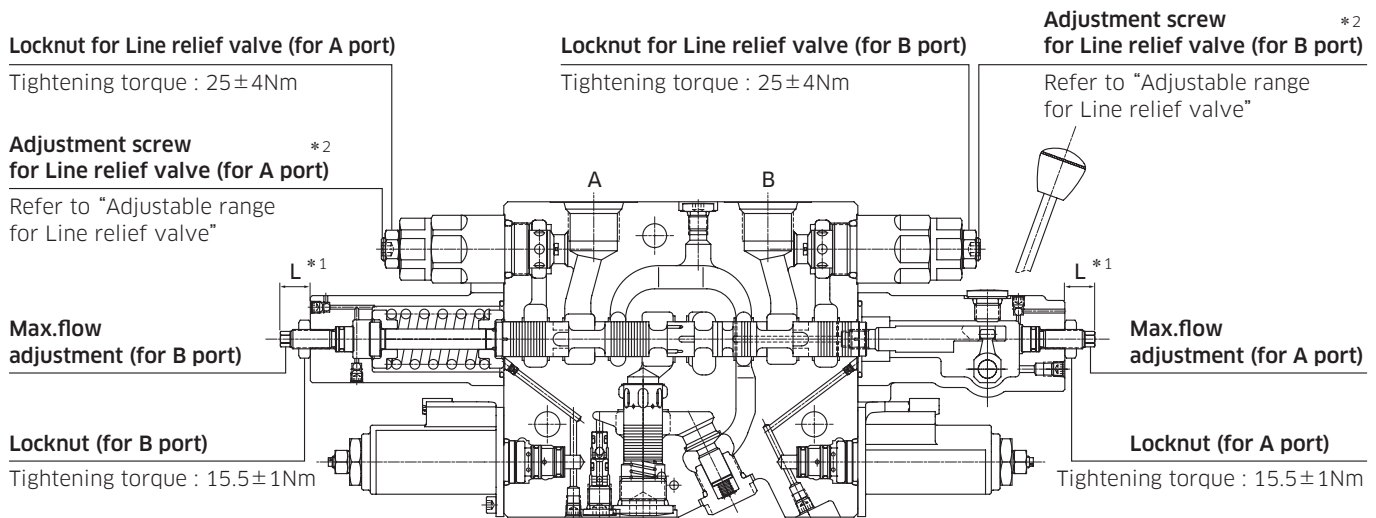

\* 1 : Dimension "L" shall be adjusted as follows.

With Manual lever for emergency	: $L \geq 14 \text{ mm}$
Without Manual lever for emergency	: $L \geq 22.5 \text{ mm}$

\* 2 : Adjustable range for Line relief valve

Pressure setting code	100	200	350
Set pressure range .....MPa.....	3~15	10~21	17~40
Maximum flow L/min	300		
Pressure change per screw revolution	6.1	5.9	11.7

# 6 Dimensions

## 6-1 General Dimensions (with all option)

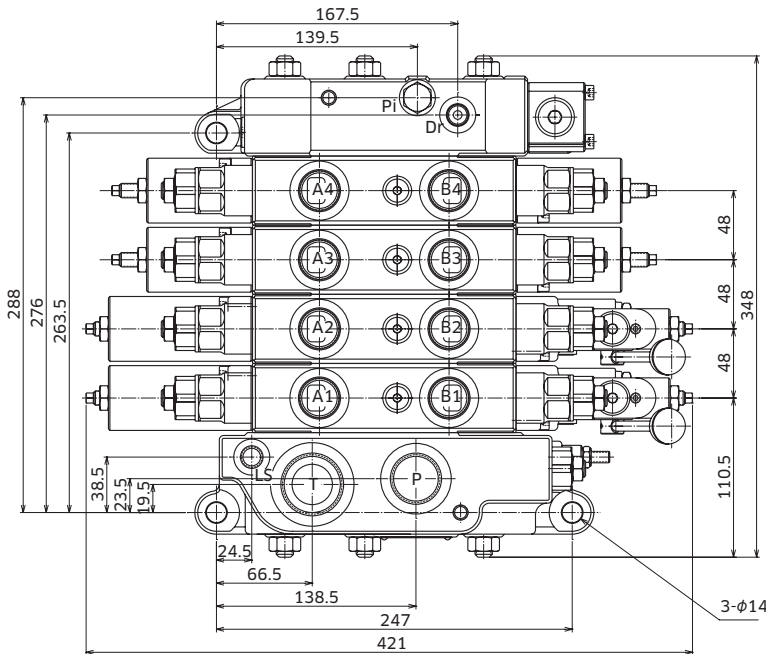

Inlet section :  
Type D  
(Main relief valve + LS relief valve +  
Unloading valve)

Spool section :  
• Type of control  
Hydraulic control : 2  
Electro-Hydraulic control : 2  
• Option : Manual lever for emergency

End cover :  
Reducing valve for internal pilot

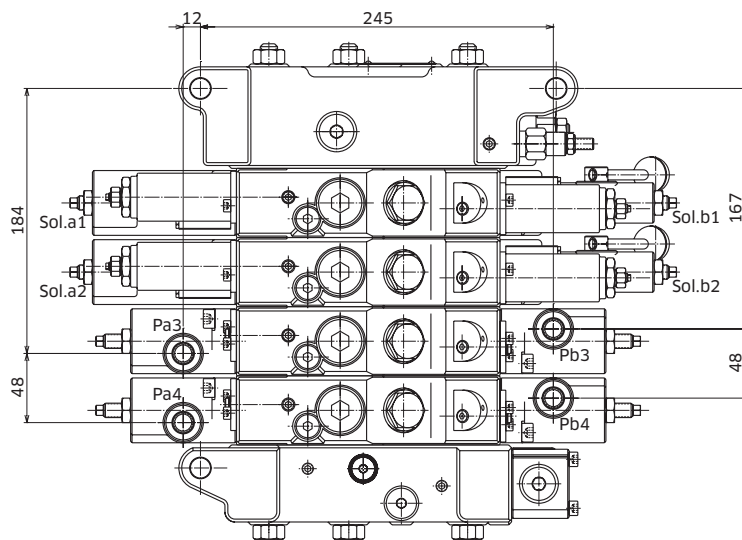
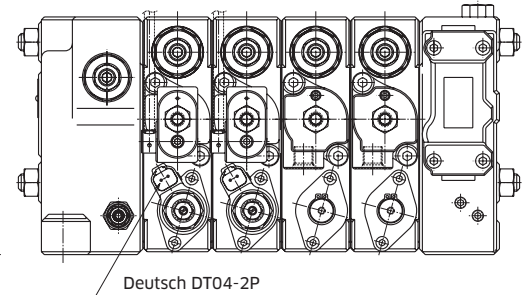
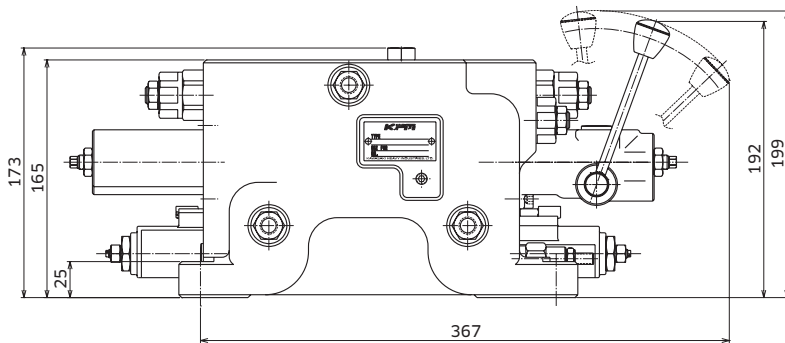

## 6-2 Port size

ID	Port name	Thread port type (O-ring boss)	
A#/B#	Work port	1-1/16-12UN-2B SAE J1926-1	G 3/4
P	Pump port	1-5/16-12UN-2B SAE J1926-1	G 1
T	Tank port	1-5/8-12UN-2B SAE J1926-1	G 1-1/4
Dr	Drain port	9/16-18UNF-2B SAE J1926-1	G 1/4
LS	LS port	9/16-18UNF-2B SAE J1926-1	G 1/4
Pi	Pilot pressure port for external supply (Electro-Hydraulic control)	9/16-18UNF-2B SAE J1926-1	G 1/4
Pa#/Pb#	Pilot pressure port (Hydraulic control)	9/16-18UNF-2B SAE J1926-1	G 1/4

# 7 Ordering Sample

- Inlet Section  
Function ..... Refer to page 12
- Spool Section  
Type of Control ..... Refer to page 15  
Type of Main spool ..... Refer to page 16  
Spool Code ..... Refer to page 17  
Line relief valve setting ..... Refer to page 16
- Specification for Solenoid valve (For Electro-Hydraulic) ..... Refer to page 11
- Thread port type (O-ring boss) ..... Refer to page 22

## Sample



## KLSV18 Inquiry Form

Please fill in the bold line, or tick in the box.

Date: yyyy/mm/dd \_\_\_\_\_  
 Type of Application: Wheel loader \_\_\_\_\_  
 Customer Name: \*\*\*\*\* \_\_\_\_\_  
 Machine Model: \*\*\*\*\* \_\_\_\_\_

### Inlet Section

Functions	Specification	Remarks
Main relief valve (Standard)	<u>35</u> MPa @ <u>30</u> L/min	
LS relief valve (Option) <input type="checkbox"/> With <input checked="" type="checkbox"/> Without	_____ MPa @ _____ L/min	
Unloading valve (Option) <input checked="" type="checkbox"/> With <input type="checkbox"/> Without	MAX 50 L/min	

### Spool Section

Section No.	Type of Control	Type of Main Spool	Port	Max. Flow (L/min)	Spool code	Line relief valve setting	Function (Actuator type)	Remarks
1	<input type="checkbox"/> Hyd, pilot <input type="checkbox"/> Electro-Hydraulic <input checked="" type="checkbox"/> Electro-Hydraulic + Manual lever	<input type="checkbox"/> Three position spool (Standard) <input type="checkbox"/> Three position spool (Motor with restriction) Four position spool with float function <input checked="" type="checkbox"/> for A port <input type="checkbox"/> for B port	A	180	A	<u>32</u> MPa @ <u>30</u> L/min <input type="checkbox"/> Not Required	Cylinder Boom	
			B	160	A	<u>32</u> MPa @ <u>30</u> L/min <input type="checkbox"/> Not Required		
2	<input type="checkbox"/> Hyd, pilot <input type="checkbox"/> Electro-Hydraulic <input checked="" type="checkbox"/> Electro-Hydraulic + Manual lever	<input checked="" type="checkbox"/> Three position spool (Standard) <input type="checkbox"/> Three position spool (Motor with restriction) Four position spool with float function <input type="checkbox"/> for A port <input type="checkbox"/> for B port	A	120	C	<u>32</u> MPa @ <u>30</u> L/min <input type="checkbox"/> Not Required	Cylinder Bucket	
			B	100	C	<u>32</u> MPa @ <u>30</u> L/min <input type="checkbox"/> Not Required		
3	<input type="checkbox"/> Hyd, pilot <input type="checkbox"/> Electro-Hydraulic <input checked="" type="checkbox"/> Electro-Hydraulic + Manual lever	<input checked="" type="checkbox"/> Three position spool (Standard) <input type="checkbox"/> Three position spool (Motor with restriction) Four position spool with float function <input type="checkbox"/> for A port <input type="checkbox"/> for B port	A	180	A	_____ MPa @ _____ L/min <input checked="" type="checkbox"/> Not Required	Cylinder Option 1	
			B	180	A	_____ MPa @ _____ L/min <input checked="" type="checkbox"/> Not Required		
4	<input checked="" type="checkbox"/> Hyd, pilot <input type="checkbox"/> Electro-Hydraulic <input type="checkbox"/> Electro-Hydraulic + Manual lever	<input checked="" type="checkbox"/> Three position spool (Standard) <input type="checkbox"/> Three position spool (Motor with restriction) Four position spool with float function <input type="checkbox"/> for A port <input type="checkbox"/> for B port	A	180	A	_____ MPa @ _____ L/min <input checked="" type="checkbox"/> Not Required	Option 2	
			B	180	A	_____ MPa @ _____ L/min <input checked="" type="checkbox"/> Not Required		

### Specification for Solenoid valve (For Electro - Hydraulic)

Rated voltage  12V  24V  
 Solenoid Connector  Deutsch

### Other Specifications

Thread port type (O-ring boss)  G type  SAE J1926-1  
 Pilot Pressure supply (in case of Electro - Hydraulic control)  Internal supply (with reducing valve)  External supply

### Hydraulic Circuit Sample

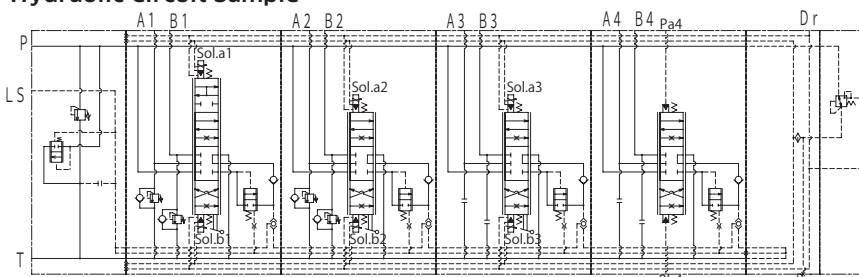

Please fill the table to specify the requirements.  
Please contact us for any questions.

## KLSV18 Inquiry Form

 **Kawasaki**  
Powering your potential

Please fill in the bold line, or tick in the box.

Date: \_\_\_\_\_

Type of Application: \_\_\_\_\_

Customer Name: \_\_\_\_\_

Machine Model: \_\_\_\_\_

### Inlet Section

Functions	Specification	Remarks
Main relief valve (Standard)	_____ MPa @ _____ L/min	
LS relief valve (Option) <input type="checkbox"/> With <input type="checkbox"/> Without	_____ MPa @ _____ L/min	
Unloading valve (Option) <input type="checkbox"/> With <input type="checkbox"/> Without	MAX 50 L/min	

### Spool Section

Section No.	Type of Control	Type of Main Spool	Port	Max. Flow (L/min)	Spool code	Line relief valve setting	Function (Actuator type)	Remarks
1	<input type="checkbox"/> Hyd, pilot <input type="checkbox"/> Electro-Hydraulic <input type="checkbox"/> Electro-Hydraulic + Manual lever	<input type="checkbox"/> Three position spool (Standard) <input type="checkbox"/> Three position spool (Motor with restriction) Four position spool with float function <input type="checkbox"/> for <b>A</b> port <input type="checkbox"/> for <b>B</b> port	A			_____ MPa @ _____ L/min <input type="checkbox"/> Not Required		
			B			_____ MPa @ _____ L/min <input type="checkbox"/> Not Required		
2	<input type="checkbox"/> Hyd, pilot <input type="checkbox"/> Electro-Hydraulic <input type="checkbox"/> Electro-Hydraulic + Manual lever	<input type="checkbox"/> Three position spool (Standard) <input type="checkbox"/> Three position spool (Motor with restriction) Four position spool with float function <input type="checkbox"/> for <b>A</b> port <input type="checkbox"/> for <b>B</b> port	A			_____ MPa @ _____ L/min <input type="checkbox"/> Not Required		
			B			_____ MPa @ _____ L/min <input type="checkbox"/> Not Required		
3	<input type="checkbox"/> Hyd, pilot <input type="checkbox"/> Electro-Hydraulic <input type="checkbox"/> Electro-Hydraulic + Manual lever	<input type="checkbox"/> Three position spool (Standard) <input type="checkbox"/> Three position spool (Motor with restriction) Four position spool with float function <input type="checkbox"/> for <b>A</b> port <input type="checkbox"/> for <b>B</b> port	A			_____ MPa @ _____ L/min <input type="checkbox"/> Not Required		
			B			_____ MPa @ _____ L/min <input type="checkbox"/> Not Required		
4	<input type="checkbox"/> Hyd, pilot <input type="checkbox"/> Electro-Hydraulic <input type="checkbox"/> Electro-Hydraulic + Manual lever	<input type="checkbox"/> Three position spool (Standard) <input type="checkbox"/> Three position spool (Motor with restriction) Four position spool with float function <input type="checkbox"/> for <b>A</b> port <input type="checkbox"/> for <b>B</b> port	A			_____ MPa @ _____ L/min <input type="checkbox"/> Not Required		
			B			_____ MPa @ _____ L/min <input type="checkbox"/> Not Required		
5	<input type="checkbox"/> Hyd, pilot <input type="checkbox"/> Electro-Hydraulic <input type="checkbox"/> Electro-Hydraulic + Manual lever	<input type="checkbox"/> Three position spool (Standard) <input type="checkbox"/> Three position spool (Motor with restriction) Four position spool with float function <input type="checkbox"/> for <b>A</b> port <input type="checkbox"/> for <b>B</b> port	A			_____ MPa @ _____ L/min <input type="checkbox"/> Not Required		
			B			_____ MPa @ _____ L/min <input type="checkbox"/> Not Required		
6	<input type="checkbox"/> Hyd, pilot <input type="checkbox"/> Electro-Hydraulic <input type="checkbox"/> Electro-Hydraulic + Manual lever	<input type="checkbox"/> Three position spool (Standard) <input type="checkbox"/> Three position spool (Motor with restriction) Four position spool with float function <input type="checkbox"/> for <b>A</b> port <input type="checkbox"/> for <b>B</b> port	A			_____ MPa @ _____ L/min <input type="checkbox"/> Not Required		
			B			_____ MPa @ _____ L/min <input type="checkbox"/> Not Required		
7	<input type="checkbox"/> Hyd, pilot <input type="checkbox"/> Electro-Hydraulic <input type="checkbox"/> Electro-Hydraulic + Manual lever	<input type="checkbox"/> Three position spool (Standard) <input type="checkbox"/> Three position spool (Motor with restriction) Four position spool with float function <input type="checkbox"/> for <b>A</b> port <input type="checkbox"/> for <b>B</b> port	A			_____ MPa @ _____ L/min <input type="checkbox"/> Not Required		
			B			_____ MPa @ _____ L/min <input type="checkbox"/> Not Required		
8	<input type="checkbox"/> Hyd, pilot <input type="checkbox"/> Electro-Hydraulic <input type="checkbox"/> Electro-Hydraulic + Manual lever	<input type="checkbox"/> Three position spool (Standard) <input type="checkbox"/> Three position spool (Motor with restriction) Four position spool with float function <input type="checkbox"/> for <b>A</b> port <input type="checkbox"/> for <b>B</b> port	A			_____ MPa @ _____ L/min <input type="checkbox"/> Not Required		
			B			_____ MPa @ _____ L/min <input type="checkbox"/> Not Required		
9	<input type="checkbox"/> Hyd, pilot <input type="checkbox"/> Electro-Hydraulic <input type="checkbox"/> Electro-Hydraulic + Manual lever	<input type="checkbox"/> Three position spool (Standard) <input type="checkbox"/> Three position spool (Motor with restriction) Four position spool with float function <input type="checkbox"/> for <b>A</b> port <input type="checkbox"/> for <b>B</b> port	A			_____ MPa @ _____ L/min <input type="checkbox"/> Not Required		
			B			_____ MPa @ _____ L/min <input type="checkbox"/> Not Required		

### Specification for Solenoid valve (For Electro - Hydraulic)

Rated voltage	<input type="checkbox"/> 12V	<input type="checkbox"/> 24V
Solenoid Connector	<input type="checkbox"/> Deutsch	

### Other Specifications

Thread port type (O-ring boss)	<input type="checkbox"/> G type <input type="checkbox"/> SAE J1926-1
Pilot Pressure supply (in case of Electro - Hydraulic control)	<input type="checkbox"/> Internal supply (with reducing valve) <input type="checkbox"/> External supply

### Comments (Other requirements)









As HANSA-TMP has a very extensive range of products and some products have a variety of applications, the information supplied may often only apply to specific situations.

If the catalogue does not supply all the information required, please contact HANSA-TMP.

In order to provide a comprehensive reply to queries we may require specific data regarding the proposed application.

Whilst every reasonable endeavour has been made to ensure accuracy, this publication cannot be considered to represent part of any contract, whether expressed or implied.

The data in this catalogue refer to the standard product. The policy of HANSA-TMP consists of a continuous improvement of its products. It reserves the right to change the specifications of the different products whenever necessary and without giving prior information.

---

## Exclusive Distributor for Italy:

---



**HANSA-TMP S.r.l.**

Via M. L. King, 6 – 41122 Modena (ITALY)  
Tel.: +39 059 415 711  
Fax: +39 059 415 730  
E-mail: [hansatmp@hansatmp.it](mailto:hansatmp@hansatmp.it)  
Website: [www.hansatmp.it](http://www.hansatmp.it)

**Certified Company**

ISO 9001:2015 – ISO 14001:2015



Share Capital: € 300.000,00  
VAT Number: IT01167360369  
REA Number: MO-225785